

# SITAGACTIVE



Design: SITAG AG

**SITAG**  
by Nowy Styl





**| D | VIELSEITIGKEIT, HOHE STABILITÄT UND KLARE LINIENFÜHRUNG** zeichnen das SITAGACTIVE Arbeitsplatzsystem aus. Die grosse Auswahl an Tischformen bietet viel Freiraum bei der Gestaltung und eine Vielzahl an bedarfsgerechten Lösungen. Vom Einzelarbeitsplatz bis zum kommunikativen Teamarbeitsplatz deckt SITAGACTIVE alle Anforderungen ab, die heute an ein modernes Arbeitsplatzsystem gestellt werden.

**| E | GOOD IN FORM.** Versatility, great stability, and clean proportions characterize the SITAGACTIVE workplace system. The large selection of table shapes offers a great deal of leeway in organization, as well as many solutions in accordance with the customer's needs. From individual workplaces up to communicative team workplaces – SITAGACTIVE covers all requirements that are placed today on an advanced workplace system.

**| F | EN BONNE FORME.** Le système visant les postes de travail SITAGACTIVE se singularise par sa souplesse d'emploi, sa grande robustesse et la subtilité de ses lignes. Les formes variées des plans de travail offrent une grande souplesse de configuration ainsi que bon nombre de solutions adaptées aux besoins de l'utilisateur. Du poste de travail individuel au poste de travail partagé, SITAGACTIVE satisfait à toutes les exigences requises par l'utilisateur en vue d'un système de postes de travail résolument moderne.

**| I | IN OTTIMA FORMA.** Versatilità, grande stabilità e chiare linee sono le caratteristiche distintive del sistema per postazione di lavoro SITAGACTIVE. Il grande assortimento di forme per il tavolo offre grande libertà creativa e una moltitudine di soluzioni specifiche alle esigenze. Dalla postazione singola a cumulative soluzioni per team, SITAGACTIVE soddisfa tutti i requisiti di un moderno sistema per postazione di lavoro.



**| D | SITAGACTIVE REIHT SICH NAHTLOS EIN.** Durch die Vielzahl an rechteckigen und segmentförmigen Tischgrößen, Farben und Plattenoberflächen passt SITAGACTIVE harmonisch zu allen Büroeinrichtungsprogrammen. Eine Vielzahl von Anbauelementen ermöglichen eine Anpassung an fast jede räumliche Gegebenheit oder Arbeitssituation.

**| E | SITAGACTIVE SMOOTHLY FITS IN.** The great number of available rectangular and segment-formed table shapes, colours, and desktop surfaces means that SITAGACTIVE harmoniously matches all lines of office furnishings. The extensive selection of add-on elements enables adaptation to virtually all space circumstances and work situations.

**| F | SITAGACTIVE S'INTÈGRE À LA PERFECTION.** Grâce aux multiples formes rectangulaires et segmentées des plans de travail, aux finitions et coloris divers, SITAGACTIVE se marie harmonieusement avec tous les programmes de mobilier de bureau. Les multiples extensions offrent des solutions adaptées à tout contexte et à toutes les conditions de travail.

**| I | SITAGACTIVE SI INTEGRA PERFETTAMENTE.** Grazie alla grande varietà di misure rettangolari e segmentate e al grande assortimento di colori e finiture del piano, i tavoli SITAGACTIVE si integrano armoniosamente in tutti i programmi di arredamento per uffici. Una vasta scelta di elementi componibili consente inoltre un adattamento ad ogni situazione spaziale o lavorativa.





**| D | DIESES ZUKUNFTSOFFENE MÖBLIERUNGSSYSTEM** trägt dem individuellen Wunsch nach anforderungskonformer Arbeitsumgebung Rechnung und lässt ablauf- und prozessorganisatorisch freien Spielraum.

**| E | GREAT ADAPTABILITY** – this office-furnishing system, open to the future, takes full account of individual wishes for a work environment that satisfies all requirements – and allows a great deal of leeway for the organization of office procedures and processes.

**| F | LA CAPACITÉ D'ADAPTATION.** Ce système de mobilier résolu- ment porteur d'avenir tient compte du besoin personnalisé en matière d'espace de bureau conformément aux exigences requises et laisse toute latitude dans l'organisation des opérations et processus de travail.

**| I | GRANDE FLESSIBILITÀ.** QUESTO FUTURIBILE SISTEMA DI MOBILI viene incontro all'esigenza individuale di un ambiente di lavoro che sappia soddisfare i requisiti specifici lasciando le dovute libertà per l'organizzazione dei processi.



**PW**  
perlweiss  
oyster white  
blanc perle  
bianco perla



**AM**  
anthrazit-metallic  
anthracite-metallic  
anthracite métallisé  
antracite metallizzato



**CR**  
verchromt (nur für Kopf- und  
Fussausleger)  
chrome-finish (only for head  
and leg stabilizers)  
chromé (uniquement colonne  
et piètement)  
cromato (solo per testa e  
base)



**MU3A**  
silber  
silver  
argent  
argento

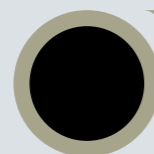

**SW**  
schwarz  
black  
noir  
nero

**| D | DAS UNTERGESTELL** gibt es in in verschiedenen Farbvarian- ten, die Tischplatten in ausgewählten Hölzern der Holzgruppen 1-3 sowie in 8 Kunststoffoberflächen. Durch Gleitlack sind die Te- leskopteile in der gleichen Farbe wie das Untergestell erhältlich.

**| E | THE DESK BASE** is available in various color variations. The desk top can be ordered in select wood types from wood groups 1 to 3, as well as in 8 synthetic surfaces. With the use of lubricant paint, the telescopic parts are available in the same colours as the desk base.

**| F | LE CHÂSSIS** se décline en différentes couleurs, tandis que le plateau existe en bois appartenant aux classes 1 à 3 ainsi qu'en 8 finitions synthétiques. Grâce au vernis de glissement, les parties télescopiques sont disponibles dans le même coloris que le châssis.

**| I | IL BASAMENTO** è disponibile in diverse variazioni di colore e i piani del tavolo in legni selezionati del gruppo 13 e in 8 diverse finiture in sintetico. I componenti telescopici sono trattati con vernice lubrificante negli stessi colori del basamento.





## MECHANISCHE HÖHENVERSTELLUNG

**| D |** Durch Lösen einer Inbusschraube kann der Tisch schnell und einfach in der Höhe eingestellt werden. Verstellbereich 65 – 85 cm.

**| E |** MECHANICAL HEIGHT ADJUSTMENT. Loosening a hexagonal socket screw makes it easy to quickly and simply adjust the height of the desk. Height adjustment is possible between 65 and 85 cm.

**| F |** RÉGLAGE MÉCANIQUE DE LA HAUTEUR. Le réglage de hauteur de la table s'obtient rapidement par simple desserrage d'une vis à 6-pans creux. Plage de réglage de 65 à 85 cm.

**| I |** REGOLAZIONE MECCANICA DELL'ALTEZZA. Svitando una vite ad esagono incassato si può regolare in modo rapido e facile l'altezza del tavolo. Gamma di regolazione: 65-85 cm.

## ELEKTRISCHE HÖHENVERSTELLUNG

**| D |** Der Elektrotisch SITAGACTIVE ist stabil, leise und schnell, seine Qualität ist ausgezeichnet und bietet ein sehr gutes Preis-/Leistungsverhältnis. Der Verstellbereich beim Einfach-Teleskop ist 72 – 120 cm, beim Zweifach-Teleskop 64 – 129 cm. Bei elektrisch höhenverstellbaren Tischen mit Kabelkanal können keine Untergestellkorpusse eingesetzt werden.

**| E |** ELECTRICAL HEIGHT ADJUSTMENT. The SITAGACTIVE electrodesk is stable, quiet and fast. It offers premium quality with an excellent benefit-cost ratio. The vertical setting range for the single-telescope model is 72 to 120 cm, and the range for the double-telescope model is 64 to 129 cm. Underdesk pedestals cannot be used with the electrodesk model with cable duct.

**| F |** RÉGLAGE ÉLECTRIQUE DE LA HAUTEUR. La table à réglage électrique SITAGACTIVE est robuste, silencieuse et rapide. De qualité exceptionnelle, elle offre un excellent rapport qualité/prix. La plage de réglage du pied télescopique simple est de 72 à 120 cm et celle du pied télescopique double est de 64 à 129 cm. Le modèle à réglage électrique avec passe-câbles ne peut recevoir de caisson.

**| I |** REGOLAZIONE ELETTRICA DELL'ALTEZZA. Il tavolo elettrico SITAGACTIVE è robusto, silenzioso e veloce, di qualità eccellente e con un ottimo rapporto qualità-prezzo. La gamma di regolazione è 72 – 120 cm in caso di gambe telescopiche semplici e 64 – 129 cm in caso di gambe telescopiche doppie. Nella versione con regolazione elettrica dell'altezza con canale portacavi, non possono essere impiegati corpi di basamento.

## EINFACH-TELESKOP

| Single telescope | Pied télescopique simple | Gamba telescopica semplice

## ZWEIFACH-TELESKOP

| Double telescope | Pied télescopique double | Gamba telescopica doppia



**| D |** Da die Tische von SITAGACTIVE keine zusätzliche Traverse besitzen, können sie mit Untergestellkorpusen kombiniert werden. Der beidseitig abklappbare Kabelkanal kann auch nachträglich montiert werden – ein Plus an Flexibilität und Anpassung an veränderte Einsatzbedingungen.

**| E |** Since these SITAG desks have no additional cross-bars, they can be combined with mobile underdesk pedestals. The double-sided swing-away cable duct can also be retrofitted – for extra flexibility and matching to changes in conditions of desk use.

**| F |** Les tables SITAGACTIVE ne possédant pas de traverse supplémentaire, elles peuvent héberger des caissons. Le passe-câbles rabattable de part et d'autre est livrable en équipement évolutif – un plus en termes de flexibilité et d'adaptation si les conditions d'utilisation venaient à changer.

**| I |** Non disponendo di traversa supplementare, i tavoli SITAGACTIVE possono essere combinati con corpi di basamento. La canalina portacavi apribile a ribalto su entrambi i lati può essere montata anche in un secondo momento: un ulteriore vantaggio di flessibilità e adattabilità a mutate condizioni di utilizzo.

**| D | HÖHENVERSTELLBARE TISCHE FÖRDERN DEN WECHSEL ZWISCHEN STEHEN UND SITZEN.** Das entlastet den Rücken, trainiert die Haltungsmuskulatur, verbessert die Atmung, regt Kreislauf sowie Verdauung an und führt damit zu einem allgemein besseren Wohlbefinden. SITAG bietet mit SITAGACTIVE ein Tischprogramm an, das dem Trend zu höhenverstellbaren Arbeitstischen Rechnung trägt und sich durch seine Gestaltung und seine Variationsmöglichkeiten hervorragend in jedes Büroumfeld integrieren lässt.

**| E | DESKS WITH MOTOR-DRIVEN HEIGHT ADJUSTMENT PROMOTE CHANGES BETWEEN STANDING, SITTING, AND MOVING.** This relieves the back, trains posture muscles, improves breathing, stimulates cardiovascular and gastro-intestinal systems, and promotes general well-being. With its SITAGACTIVE line of models, SITAG offers a desk range that meets the trend to desks with variable height. The design and variation possibilities allow SITAGACTIVE to be highly effectively integrated into any office ambience.

**| F | LES TABLES RÉGLABLES EN HAUTEUR ENCOURAGENT L'ALTERNANCE** entre la position assise et la position debout. Cette fonction soulage le dos, entraîne la musculation en vue d'une bonne tenue, améliore la respiration, stimule la circulation sanguine ainsi que la digestion et procure un meilleur bien-être général. A travers SITAGACTIVE, SITAG propose des modèles de tables répondant à la tendance actuelle en matière de réglage de hauteur et s'intégrant remarquablement bien dans tous les espaces bureau grâce à leur conception et à leurs variations possibles.

**| I | MUOVERSI FA BENE.** Tavoli ad altezza regolabile favoriscono il passaggio da posizione in piedi a posizione a sedere. Questo alleggerisce la schiena, esercita la muscolatura responsabile di una postura corretta, migliora la respirazione, stimola la circolazione e la digestione contribuendo ad una migliore sensazione di benessere generale. In SITAGACTIVE, SITAG propone un programma di tavoli in sintonia con il trend dei tavoli di lavoro ad altezza regolabile e con una versatilità e design tali da consentire la perfetta integrazione in ogni ambiente di ufficio.



➤ **STABIL!**

➤ **LEISE!**

➤ **SCHNELL!**

➤ **GROSSER VERSTELLBEREICH!**

➤ **KEINE ZUSÄTZLICHE TRAVERSE, DAHER UNTERSTELLKORPUS MÖGLICH!**









**| D | DIE ELEGANTE LÖSUNG** für kleinen Raum. Der SITAG ORGATOWER als perfekte Ergänzung auch zum SITAGACTIVE Tischprogramm schafft auf kleinster Fläche genügend Stauraum und Ablagefläche direkt am Arbeitstisch. Er ist als SITAG ORGATOWER BASIC, SITAG ORGATOWER LIGHT und SITAG ORGATOWER in 3 Größen und verschiedenen Ausführungen lieferbar und hält seinem Benutzer alles Benötigte unmittelbar am Arbeitsplatz zugriffsbereit.

**| E | THE ELEGANT SOLUTION** for small spaces. The SITAG ORGATOWER as perfect complement – also to the SITAGACTIVE desk line – creates sufficient storage and filing space with a minimum of footprint: directly at the work desk. It is available as SITAG ORGATOWER BASIC, SITAG ORGATOWER LIGHT and SITAG ORGATOWER, in 3 sizes and various versions. They offer their users everything needed, at arm's length and directly at the desk.

**| F | UNE SOLUTION ÉLÉGANTE** pour les petits espaces. La SITAG ORGATOWER vient compléter la gamme de tables SITAGACTIVE à la perfection. Elle offre de la place et de la surface de rangement en suffisance, directement à côté du poste de travail. Vous avez le choix entre la SITAG ORGATOWER BASIC, la SITAG ORGATOWER LIGHT et la SITAG ORGATOWER, disponibles en 3 dimensions différentes et en plusieurs versions. L'utilisateur aura ainsi tout ce dont il a besoin à portée de main.

**| I | LA SOLUZIONE ELEGANTE** per spazi ridotti. Integrandosi perfettamente al programma di tavoli SITAGACTIVE, la SITAG ORGATOWER crea, anche in aree molto piccole, sufficiente spazio di riponimento ed appoggio direttamente sul tavolo di lavoro. Come SITAG ORGATOWER BASIC, SITAG ORGATOWER LIGHT e SITAG ORGATOWER è disponibile inoltre in 3 misure e diverse versioni facendo in modo che chi la utilizza possa avere a portata di mano tutto ciò di cui ha bisogno direttamente sulla postazione di lavoro.





# SITAGACTIVE: PERFEKT FÜR JEDE SITUATION

**| D | AUCH FÜR DEN REPRÄSENTATIVEN BESPRECHUNGS- ODER KONFERENZRAUM** bietet SITAGACTIVE den richtigen Tisch. Die Auswahl aus 20 Holzoberflächen und 8 Kunststoff-Beschichtungen ermöglicht auch hier stimmige Einrichtungskonzepte.

**| E | PERFECT FOR ANY SITUATION.** Also optimal for prestigious meeting or conference rooms: just the right desk for special environments, as offered by SITAGACTIVE. A selection among 20 wood surfaces and 8 synthetic coatings enables harmonious furnishing concepts here as well.

**| F | L'IDÉAL EN TOUTE CIRCONSTANCE.** Pour la luxueuse salle de réunion ou de conférence, SITAGACTIVE dispose également des tables appropriées. La sélection parmi 20 différentes finitions boisées et 8 revêtements synthétiques facilite là aussi la configuration harmonieuse du mobilier.

**| I | PERFETTO PER OGNI SITUAZIONE.** Anche per prestigiosi ambienti adibiti a meeting, colloqui o conferenze, SITAGACTIVE ha in serbo il tavolo giusto. Un assortimento di 20 superfici in legno e 8 rivestimenti in sintetico permette anche qui di realizzare dei sistemi di arredamento ben intonati.





# RICHTIG PLANEN, GEKONNT EINRICHTEN!

**| D | EIN SCHWERPUNKT** unserer Arbeit ist das besonders breite Angebot an Beratungs- und Serviceleistungen rund um das Thema Bürowelten. Nutzen Sie unsere erprobten Konzepte und innovativen Möglichkeiten. Wir helfen Ihnen gern bei der Konzeption und Raumplanung unter Einsatz modernster CAD-Anlagen, die nebst einer Grundrisseinteilung ebenso eine foto-realistische, dreidimensionale Raumansicht möglich machen.

**| E | A FOCAL POINT** of our work is our especially extensive offering of consulting and after-sales services involving the topic of office worlds. Take advantage of our proven concepts and innovative possibilities. We will be glad to help you in your concept development and space assignment planning, with the use of the latest in CAD resources. In addition to floor-plan configuration, these tools also enable photo-realistic, three-dimensional views of your office rooms.



**| F | PARMi NOS PÔLES D'ACTIVITÉ,** nous offrons un large éventail de prestations conseil et service pour tout ce qui a trait à l'univers du bureau. Profitez de nos concepts aboutis et de nos solutions innovantes. Nous vous offrons volontiers notre assistance dans la conception et l'aménagement de votre espace bureau en mettant en œuvre des équipements CAO de pointe, qui outre le plan de masse proposeront la visualisation du comportement réaliste de l'aménagement dans un environnement 3D.

**| I | GIUSTA PROGETTAZIONE, SAPIENTE ARREDAMENTO!** Un aspetto chiave del nostro lavoro è l'offerta particolarmente vasta di servizi di consulenza ed assistenza per tutto ciò che riguarda il mondo del mobile da ufficio in tutta la sua complessità. Vi invitiamo quindi a sfruttare le nostre idee, ormai ampiamente consolidate, e le innovative possibilità che vi offrono. Per quanto ci riguarda, saremo liettissimi di potervi aiutare nell'ideazione e progettazione dei locali utilizzando i più moderni impianti CAD, che oltre ad una suddivisione della planimetria permettono anche una vista del locale fotorealistica e tridimensionale.







## ARBEITSTISCHE RECHTECK 60 CM TIEF

Rectangular desks, 60 cm deep | Plans de travail rectangulaires, profondeur 60 cm | Piani di lavoro rettangolari profondi 60 cm



## ARBEITSTISCHE RECHTECK 80 CM TIEF

Rectangular desks, 80 cm deep | Plans de travail rectangulaires, profondeur 80 cm | Piani di lavoro rettangolari profondi 80 cm

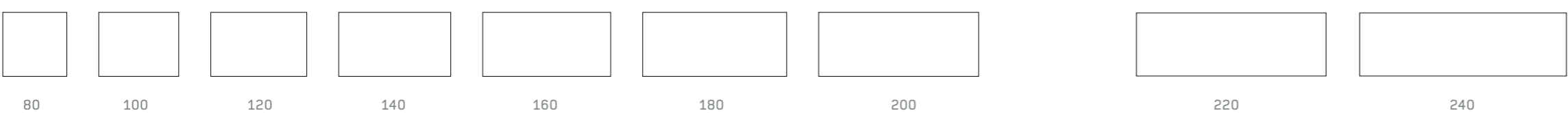

## VERBINDUNGSELEMENTE FÜR 80 CM TIEFE

Connecting elements for 80 cm depth | Éléments de liaison pour une profondeur de 80 cm | Elementi di raccordo per una profondità di 80 cm

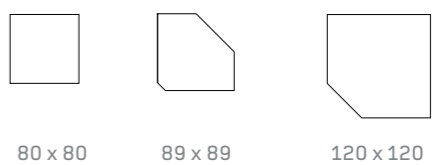

## ARBEITSTISCHE RECHTECK 90 CM TIEF

Rectangular desks, 90 cm deep | Plans de travail rectangulaires, profondeur 90 cm | Piani di lavoro rettangolari profondi 90 cm

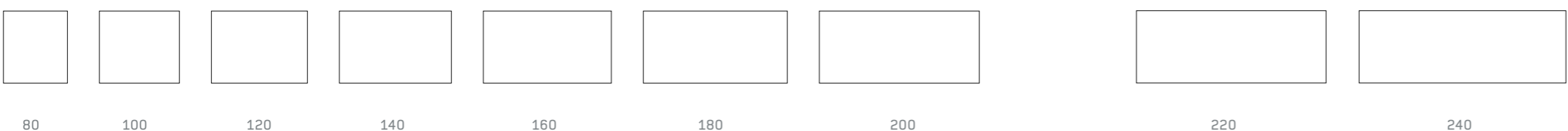

## VERBINDUNGSELEMENTE FÜR 90 CM TIEFE

Connecting elements for 90 cm depth | Éléments de liaison pour une profondeur de 90 cm | Elementi di raccordo per una profondità di 90 cm

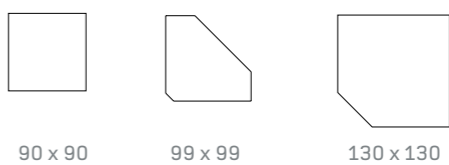

## ARBEITSTISCHE RECHTECK 100 CM TIEF

Rectangular desks, 100 cm deep | Plans de travail rectangulaires, profondeur 100 cm | Piani di lavoro rettangolari profondi 100 cm

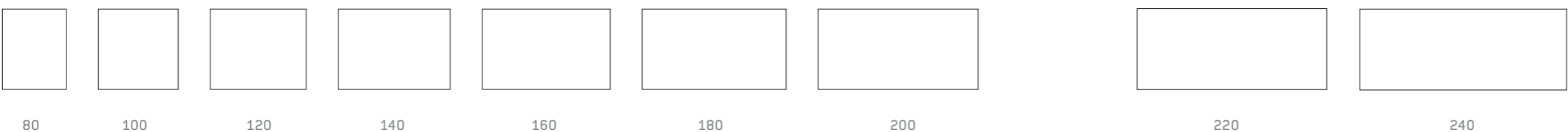

## ANBAUELEMENTE FÜR 80 CM TIEFE

Add-on elements for 80 cm depth | Éléments d'extension pour une profondeur de 80 cm | Elementi componibili per una profondità di 80 cm

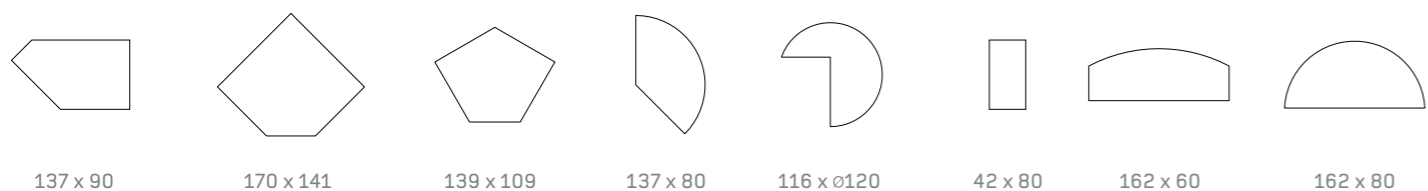

## ANBAUELEMENTE FÜR 90 CM TIEFE

Add-on elements for 90 cm depth | Éléments d'extension pour une profondeur de 90 cm | Elementi componibili per una profondità di 90 cm

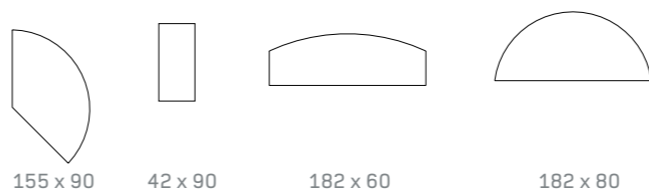

## ANBAUELEMENTE FÜR 100 CM TIEFE

Add-on elements for 100 cm depth | Éléments d'extension pour une profondeur de 100 cm | Elementi componibili per una profondità di 100 cm

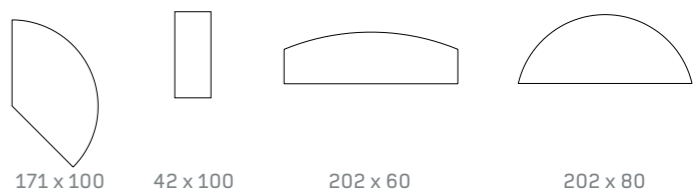



ARBEITSTISCHE FREIFORM

Free-shape desks | Plans de travail, forme quelconque | Piani di lavoro a forma libera

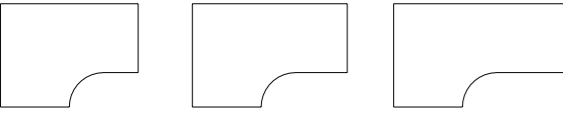

160 x 120      180 x 120      200 x 120

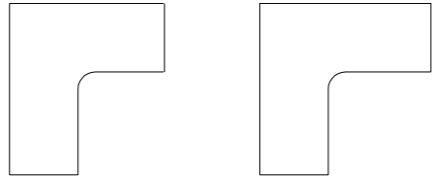

180 x 200      200 x 200

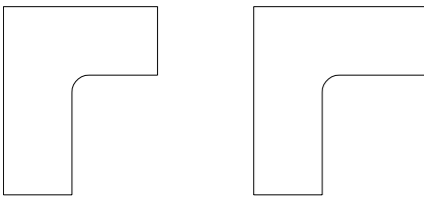

180 x 220      200 x 220

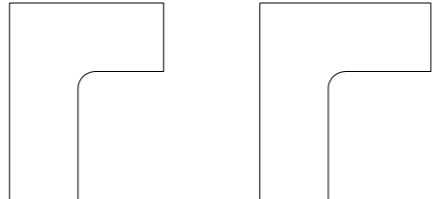

180 x 240      200 x 240

ARBEITSTISCHE SEGMENTFORM

Segment-shape desks | Plans de travail segmentés | Piani di lavoro segmentati



160 x 100      180 x 100      200 x 100

ANSATZTISCHE ZU ARBEITSTISCHEN

Extension desks | Retours de bureau | Piani di lavoro segmentati

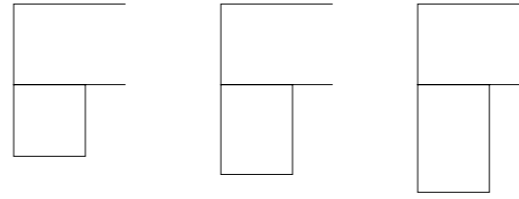

80 x 80      80 x 100      80 x 120

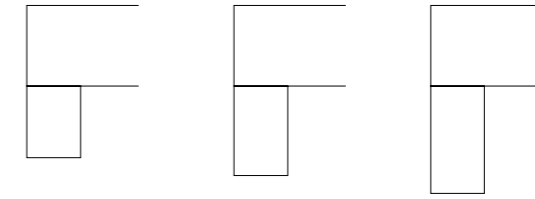

60 x 80      60 x 100      60 x 120

ARBEITSTISCHE FREIFORM 120°

Free-shape desks, 120° | Plans de travail, angle 120° | Piani di lavoro a forma libera, angolo di 120°

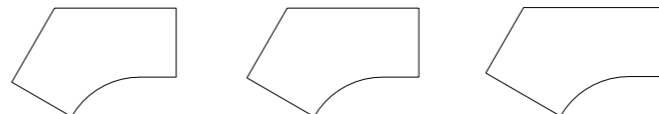

191 x 126      200 x 126      208 x 126

ARBEITSTISCHE FREIFORM 135°

Free-shape desks, 135° | Plans de travail, angle 135° | Piani di lavoro a forma libera, angolo di 135°

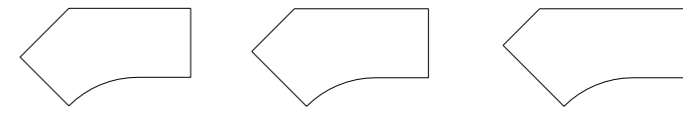

198 x 113      205 x 113      212 x 113





## BESPRECHUNGSTISCHE RECHTECK 80 TIEF

Rectangular conference tables, 80 cm deep | Tables de conférence rectangulaires, profondeur 80 cm | Tavoli per riunioni rettangolari profondi 80 cm

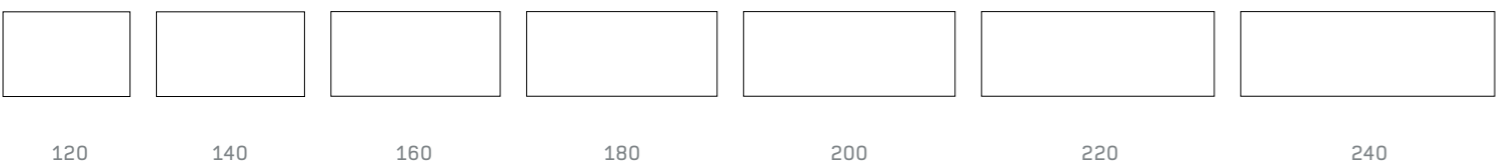

## BESPRECHUNGSTISCHE RECHTECK 90 TIEF

Rectangular conference tables, 90 cm deep | Tables de conférence rectangulaires, profondeur 90 cm | Tavoli per riunioni rettangolari profondi 90 cm

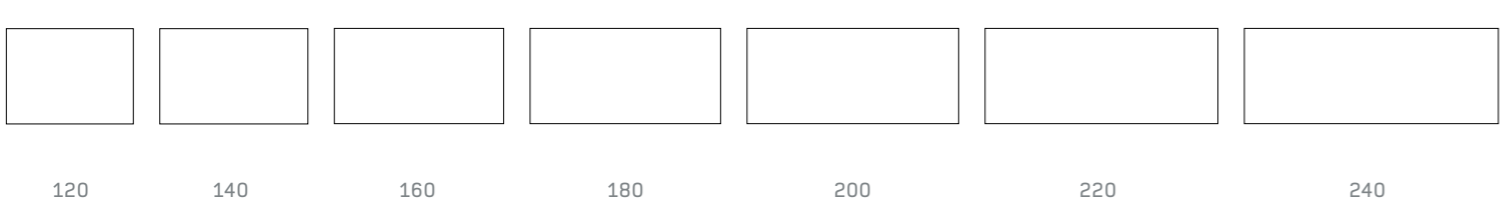

## BESPRECHUNGSTISCHE RECHTECK 100 TIEF

Rectangular conference tables, 100 cm deep | Tables de conférence rectangulaires, profondeur 100 cm | Tavoli per riunioni rettangolari profondi 100 cm

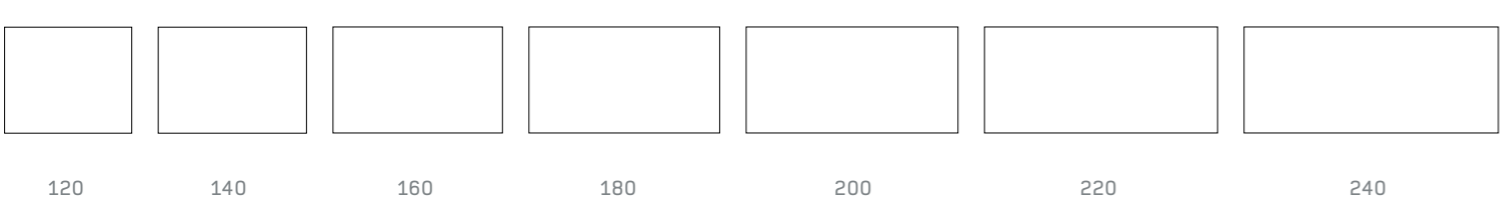

## BESPRECHUNGSTISCHE RECHTECK 120 TIEF

Rectangular conference tables, 120 cm deep | Tables de conférence rectangulaires, profondeur 120 cm | Tavoli per riunioni rettangolari profondi 120 cm

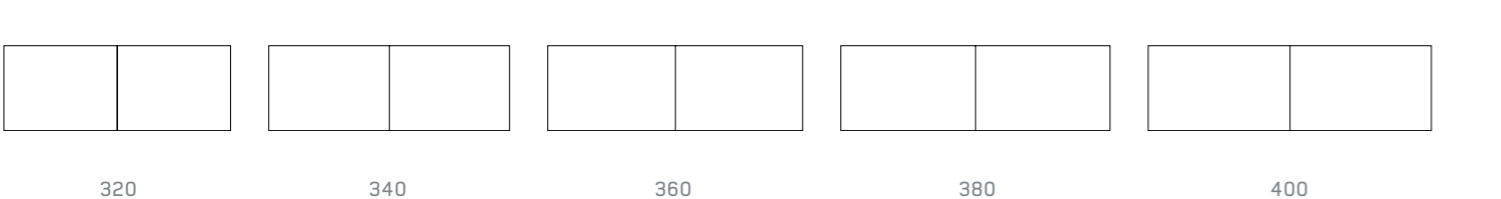

## BESPRECHUNGSTISCHE BOOTSFÖRMIG 100 TIEF 120 TIEF

Boat-shaped conference tables, 100 deep | Tables de conférence bombées, profondeur 100 cm | Tavoli per riunioni bombati profondi 100 cm

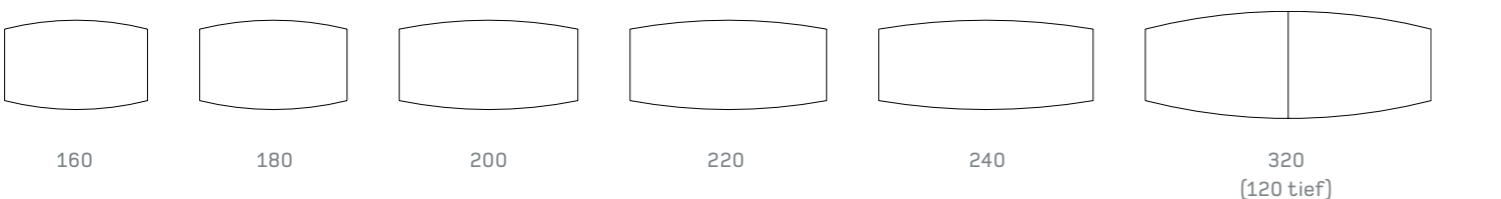

## BESPRECHUNGSTISCHE BOOTSFÖRMIG 130 TIEF

Boat-shaped conference tables, 130 cm deep | Tables de conférence bombées, profondeur 120 cm | Tavoli per riunioni bombati profondi 130 cm

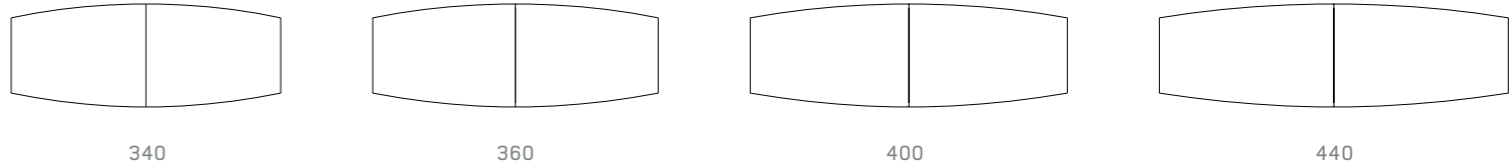

## BESPRECHUNGSTISCHE BOOTSFÖRMIG 160 TIEF

Boat-shaped conference tables, 160 cm deep | Tables de conférence bombées, profondeur 160 cm | Tavoli per riunioni bombati profondi 160 cm

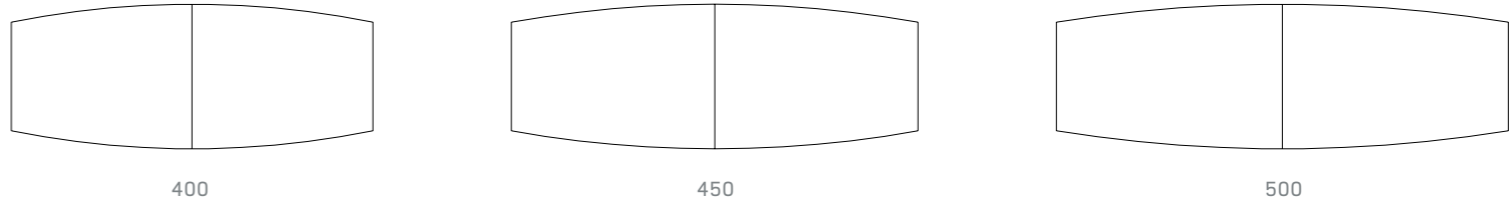

## BESPRECHUNGSTISCHE RUND

Round conference tables | Tables de travail debout rondes | Tavoli per riunioni rotondi



## BESPRECHUNGSTISCHE QUADRATISCH

Square conference tables | Tables de travail carrées | Tavoli per riunioni quadrati

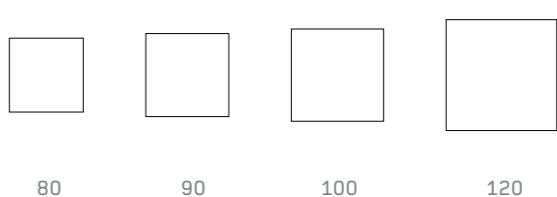

## STEHTISCHE RUND

Round stand-up tables | Tables assis-debout rondes | Tavoli per conferenze rotondi



## STEHTISCHE QUADRATISCH

Square stand-up tables | Tables assis-debout carrées | Tavoli per conferenze quadrati

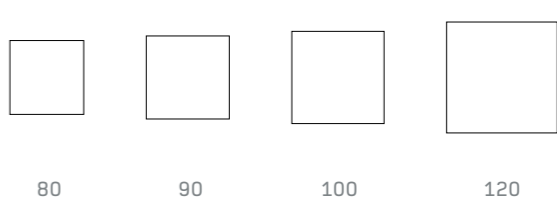

## LIFTMATISCHE SITZ-STEHTISCHE

Liftmatic sit-stand desks | Tables assis-debout à réglage pneumatique | Tavoli per conferenze liftmatic



## LIFTMATISCHE SITZ-STEHTISCHE QUADR.

Liftmatic sit-stand desks | Liftmatic sit-stand desks | Tables assis-debout carrées à réglage pneum. | Tavoli per conferenze liftmatic quadri

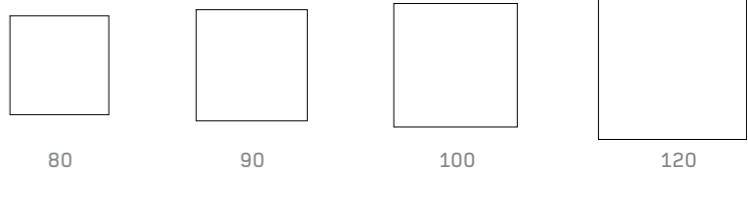



# SITAGACTIVE: DIE DETAILS



| D | Besprechungstische (rund, quadratisch oder rechteckig) sind auch höhenverstellbar erhältlich  
 | E | Stand-up meeting tables (round, square or rectangular) are also available with height adjustment  
 | F | Tables de conférence (rondes, carrées ou rectangulaires) disponibles également avec réglage de hauteur  
 | I | I tavoli per riunioni (rotondi, quadrati o rettangolari) sono disponibili anche ad altezza regolabile

| D | Tischplatten sowohl mit geraden als auch runden Ecken erhältlich  
 | E | Table tops are available with both straight and rounded corners  
 | F | Les plateaux de table sont disponibles avec des coins droits et ronds  
 | I | I piani dei tavoli sono disponibili sia con angoli dritti che arrotondati



| D | Tische sind auch mit einer Lederauflage lieferbar  
 | E | Desks are also available with a leather desk writing pad  
 | F | Les tables sont livrables également avec un revêtement cuir  
 | I | I tavoli sono disponibili anche con elemento sopratavolo in pelle



| D | Nivelliergleiter  
 | E | Gliding levelling adjuster  
 | F | Glisseur d'ajustage  
 | I | Regolatore di livello scorrevole



| D | Sichrückwand Lochblech (optional)  
 | E | Rear privacy panel, made of perforated sheet metal (optional)  
 | F | Voile de fond tôle perforée (en option)  
 | I | Pannello posteriore parrivista in lamiera perforata (optional)

| D | Tische mit Echtholz-Oberflächen gibt es wahlweise mit gerader oder mit Profilkante  
 | E | Tables with genuine-wood surfaces are available with straight or profiled edges  
 | F | Tables en finition bois véritable livrables au choix avec chant droit ou profilé  
 | I | I tavoli con finiture in vero legno sono disponibili a scelta con bordo rettilineo o profilato



| D | Schiebepatte (optional)  
 | E | Slide plate (optional)  
 | F | Plateau coulissant (en option)  
 | I | Piano scorrevole (optional)

| D | Versenkbare Komfortschaltung 4-fach programmierbar mit Memory-Funktion und Digitalanzeige (optional)  
 | E | Lowerable convenience control unit with 4 programmable options, with memory function and digital display (optional)  
 | F | Commande tout confort escamotable, 4 positions programmables avec mémoire et affichage numérique (en option)  
 | I | Comando comfort a scomparsa con 4 opzioni di programmazione, funzione memoria e indicazione digitale (optional)



| D | Elektrische Höhenverstellung mit soft Start und soft Stopp  
 | E | Electrically driven height adjustment with soft start and soft stop  
 | F | Réglage électrique de hauteur avec ralentisseurs  
 | I | Regolazione altezza elettrica con avvio e arresto morbidi



| D | Optional ausgestattet mit PIEZOtechnik, einer Sensorbrücke, welche automatisch stoppt, wenn Hindernisse im Weg sind  
 | E | Optionally equipped with PIEZO technology: a sensor bridge that provides an automatic stop when obstacles are in the way  
 | F | Équipement en option de la technologie piezo, un capteur à base de pont qui arrêtera automatiquement toute opération en cas d'obstacles  
 | I | In via opzionale dotato di sistema piezoelettrico e di un ponte sensore che induce un arresto automatico nel caso vengano incontrati degli ostacoli

| D | Materialschieber zur Montage unter der Tischplatte  
 | E | Under-desk utensil drawer  
 | F | Organisateur de tiroir à fixer sous le plateau de table  
 | I | Cassetto per materiali vari con pannello frontale





# SITAGACTIVE: DIE DETAILS



| D | Beidseitig abklappbarer Kabelkanal, auch nachträglich montierbar  
 | E | Swing-away cable duct on both sides (can also be retro-fitted)  
 | F | Passe-câbles rabattable de part et d'autre, montage ultérieur possible  
 | I | Canalina portacavi apribile a ribalto su entrambi i lati, montabile anche a posteriori

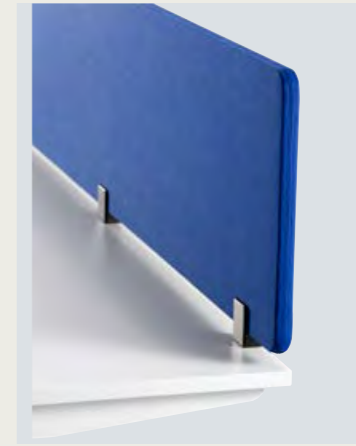

| D | Schallabsorbierende Organisationswand als Sichtschutzblende  
 | E | Sound-absorbing organization panel as privacy element  
 | F | Écran visuel acoustique  
 | I | Pannello insonorizzante paravista

| D | Aufsatzwand light  
 | E | Sound-absorbing privacy panel (light version)  
 | F | Paroi de séparation light  
 | I | Pannello applicabile Light

| D | Aufsatzwand aus PET Filzmaterial  
 | E | Attachment wall made of PET felt material  
 | D | Paroi supérieure en feutre PET  
 | I | Parete superiore in feltro di PET



| D | Schallabsorbierende Organisationswand als Sichtschutzblende für Doppelarbeitsplatz  
 | E | Sound-absorbing organization panel as privacy element for double workplaces.  
 | F | Écran visuel acoustique pour postes de travail en tandem  
 | I | Pannello insonorizzante paravista per postazione di lavoro doppia

| D | Schallabsorbierende Organisationswand mit Ablagesystem auf dritter Ebene  
 | E | Sound-absorbing organizational panel, with tray system on third level  
 | F | Écran visuel acoustique avec système de rangement 3 casiers  
 | I | Pannello insonorizzante con tre ripiani

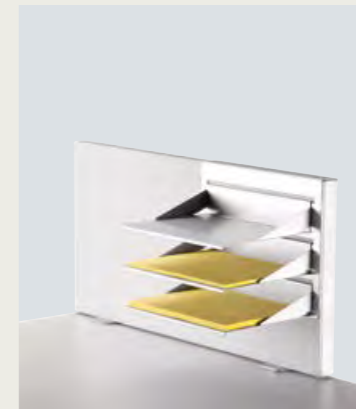

| D | Orgaprofil  
 | E | Profile with organizer  
 | F | Profilé avec organisateur  
 | I | Profilo di organizzazione

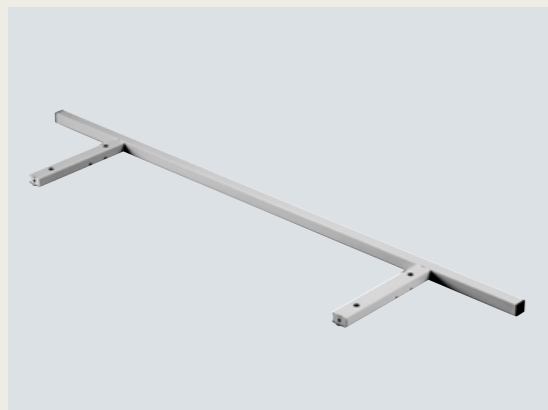

| D | SITAGACTIVE Multifunktionstraverse (MF Traverse)  
 | E | SITAGACTIVE multifunction traverse (MF traverse)  
 | F | Traverse multifonction SITAGACTIVE (Traverse MF)  
 | I | Traversa multifunzione SITAGACTIVE

| D | Wand-Tisch-Aufsatzelement Schallschutz an MF Traverse (Multifunktionstraverse)  
 | E | Desktop attachment element for noise abatement and privacy on a multifunction traverse element  
 | F | Élément de rehausse paroi/table avec isolation acoustique de la traverse MF (traverse multifonction)  
 | I | Elemento insonorizzante da applicare a parete/ tavolo su traversa MF (multifunzione)

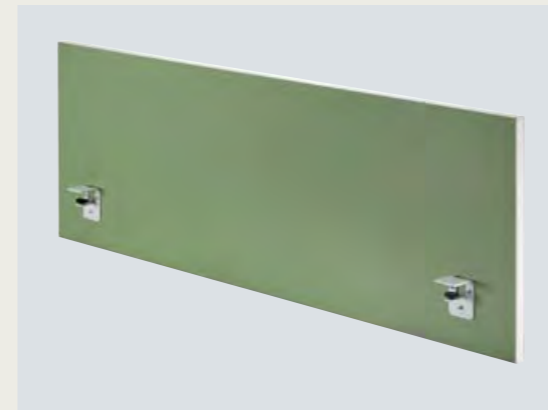

| D | Tischaufsatzelement an MF Traverse montiert  
 | E | Desktop attachment element, mounted on multifunction traverse element  
 | F | Élément de rehausse pour table monté sur traverse MF  
 | I | Elemento applicato su tavolo, montato a traversa multifunzione



| D | Magnetische CUBE Kabelschlange für EVT/ EV  
 | E | Magnetic CUBE cable snake for EVT / EV  
 | F | Gaine de câble magnétique CUBE pour EVT/EV  
 | I | Serpentina magnetica CUBE per cavi EVT/ EV



| D | Elektroschlauch in Stoff, Comfort oder Leder  
 | E | Electrical snake in fabric, convenience or leather versions  
 | F | Gaine électrique textile, confort ou cuir  
 | I | Tubo portacavi in tessuto, comfort o pelle

| D | Flexible Kabelkette  
 | E | Flexible cable chain  
 | F | Gaine technique souple  
 | I | Catena portacavi flessibile



| D | Einspeiseleitung mit Magnethalterung  
 | E | Electrical strip connector with magnetic mount  
 | F | Bloc 5 prises avec support magnétique  
 | I | Linea di alimentazione con supporto magnetico





# SITAGACTIVE: DIE DETAILS



| D | CPU-Halterung, mitlaufend  
 | E | CPU mount, with follower action  
 | F | Porte-unité centrale  
 | I | Supporto CPU



| D | Druckertablar  
 | E | Printer platform  
 | F | Tablette d'imprimante  
 | I | Mensola porta stampante



| D | Auslassdose D = 80 mm Ausführungen weiss, grau schwarz  
 | E | Wiring grommet, diam. = 80 mm, in white, grey or black  
 | F | Sortie de câble D = 80 mm, exécution blanc, gris-noir  
 | I | Passacavi D = 80 mm bianco, grigio, nero



| D | Twist zur Elektrifizierung auf der Tischplatte  
 | E | Twist outlet for power supply on the table top  
 | F | Prise Twist pour l'alimentation électrique sur le plan de travail  
 | I | Twist per l'elettrificazione sul piano del tavolo

| D | Wireless-Charger zur kabellosen Aufladung von Mobilgeräten  
 | E | Wireless charger for charging mobile devices  
 | F | Chargeur sans fil pour recharger les appareils mobiles sans installer de câbles  
 | I | WirelessCharger per la ricarica senza fili di terminali mobili



| D | Kabeldurchlass Alu 300 x 70 mm mit Klappe und Bürstendichtung, Durchlass: 270 x 40 mm  
 | E | Wiring grommet, aluminium, 300 x 70 mm, with lid cover and brush seal, opening 270 x 40 mm  
 | F | Passe-câble alu 300 x 70 mm avec clapet et joint-brosse d'étanchéité, passage : 270 x 40 mm  
 | I | Passacavi in alluminio 300 x 70 mm con sportello e guarnizione a spazzola, passaggio: 270 x 40 mm

| D | Desk 2 zur Elektrifizierung auf der Tischplatte  
 | E | Desk 2 for electrification on the table top  
 | F | Prise Desk 2 pour l'alimentation électrique sur le plan de travail  
 | I | Desk 2 per l'elettrificazione sul piano del tavolo



| D | Coni 4- und 3-fach für einseitige Bedienung  
 | E | Coni 4 x and 3 x plug strip for access from one side  
 | F | Prise Coni triple et quadruple pour utilisation unilatérale  
 | I | Coni quadrupli e tripli da utilizzare su un solo lato



| D | Power Frame 4-fach wahlweise mit Alu Klappe für beidseitige Bedienung  
 | E | Power Frame socket quadruple with optional aluminium flap for bilateral use  
 | F | Prise Power Frame quadruple avec rabat en aluminium en option pour utilisation bilatérale  
 | I | Power Frame quadruplo, a scelta, con ribalto in alluminio per utilizzo su ambo i lati

| D | Montagedetail Flo Dynamic Arm  
 | E | Installation detail for Flo Dynamic Arm  
 | F | Gros plan montage du bras support Flo Dynamic  
 | I | Particolare di montaggio braccio Flo Dynamic



| D | Flo Dynamic Arm, Belastung wahlweise 3 – 9 kg oder 6 – 18 kg  
 | E | Flo Dynamic arm, with load capacity of 3 – 9 kg or 6 – 18 kg  
 | F | Bras support Flo Dynamic, charge optionnelle 3 à 9 kg ou 6 à 18 kg  
 | I | Braccio Flo Dynamic, carico massimo: 3 – 9 kg / 6 – 18 kg



| D | Wishbone Säule  
 | E | Wishbone column  
 | F | Mât Wishbone  
 | I | Colonna Wishbone



| D | Wishbone Säule mit Wishbone Arm für zwei Bildschirme (inkl. VESA-Adapter)  
 | E | Wishbone column with wishbone arm for two computer monitors (including VESA adapters)  
 | F | Mât Wishbone avec bras Wishbone pour deux écrans (adaptateur VESA inclus)  
 | I | Colonna Wishbone con braccio Wishbone per due monitor (incl. adattatore VESA)





**SITAGXILIUM**



**SITAG**  
by Nowy Styl

**SITAGACTIVE LIFTMATIC 2.1**



**SITAG**  
by Nowy Styl

**SITAGTEAM**



**SITAG**  
by Nowy Styl

**SITAGINLINE EXECUTIVE  
SITAGINLINE CONFERENCE**



**SITAG**  
by Nowy Styl

**SITAG CABINETS**



**SITAG**  
by Nowy Styl

**SITAGACTIVE**



**SITAG**  
by Nowy Styl

**SITAGWAVE**



**SITAG**  
by Nowy Styl

**SITAG MCS TISCHSYSTEM**



**SITAG**  
by Nowy Styl

**| D |** Technische Änderungen, Druckfehler und Programmänderungen vorbehalten. Farbabweichungen von den Originalfarben sind drucktechnisch bedingt.  
**| E |** Subject to technical and programme alterations, printing errors, and other errors. Printed colours may vary from actual colours.  
**| F |** Sous réserve de modifications techniques, d'erreurs d'impression et d'altérations du programme. Les couleurs reproduites peuvent différer des couleurs originales.  
**| I |** Con riserva di modifiche tecniche, errori di stampa e cambiamenti di programma. Eventuali differenze di colore tra le immagini e i prodotti reali sono dovute alla stampa.



SITAG SA Nyon  
 Chemin du Joran 10  
 CH-1260 Nyon  
 T.+41 (0) 22 361 47 27  
 info.nyon@sitag.ch

SITAG AG  
 Brown-Boveri-Str. 5  
 8050 Zurich-Oerlikon  
 T.+41 44 8637272  
 info.zuerich@sitag.ch

Nowy Styl Headquarters  
 ul. Pużaka 49  
 38-400 Krosno, Poland  
 +48 572 900 333  
 sales@nowystyl.com

**SITAG AG**  
 Simon Frick-Str. 3  
 CH-9466 Sennwald

T +41 (0) 81 758 18 18  
 info@sitag.ch  
 www.sitag.ch

