



BELL

A striking acoustic lamp with an exceptional sound absorption performance.

Designed by Jakub Sobiepanek



ABSORPTION



LOW, MEDIUM
& HIGH TONES

MUTE.

GENERAL

Type: Pendant

Light versions: Golf LED, Downlight, E27 fitting (excl. bulb)

Recommended use:

- Golf LED option: Lobbies, Restaurants, Hotels
- Downlight option: Open-plan offices & Conference rooms

COMPOSITION

- Basotect foam
- HDF board
- Plywood
- Powder coated steel
- Source of light (glass/steel/aluminium)
- Felt
- Fabric of choice (optional bicolor finish*)

* Option of mixing 2 colours of the same fabric on inside and outside. In case of E27 or Golf LED light we recommend to choose a bright colour of fabric on the inside of the lamp to maximize its performance.

SHAPE AND DIMENSIONS mm

+/- 5mm

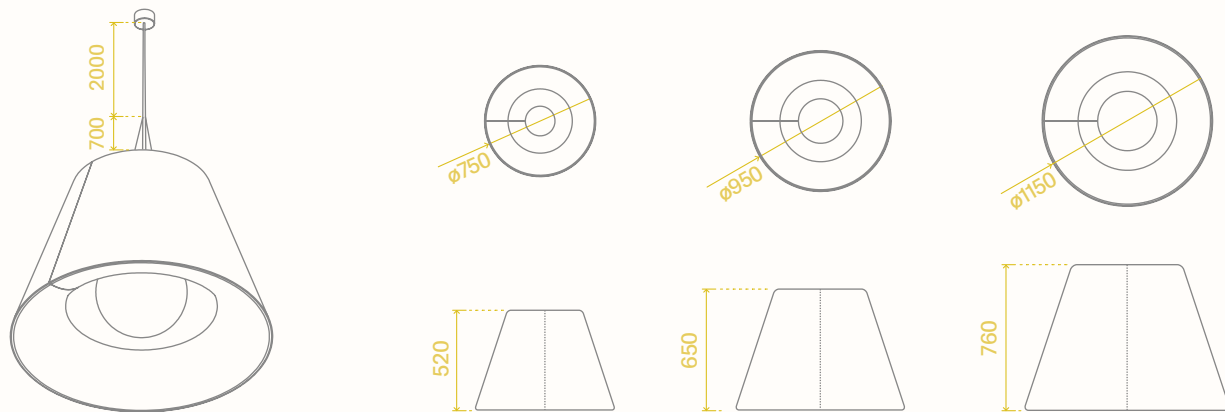

WEIGHTS kg

SIZE	E27 FITTING	GOLF LED	DOWNLIGHT
ø750 mm	9	10,5	10
ø950 mm	12,5	15	13,5
ø1150 mm	15	19	17

ACOUSTIC PROPERTIES



Absorption



Low, medium and high tones

SOUND ABSORPTION A_{OBJ} PER ISO 354

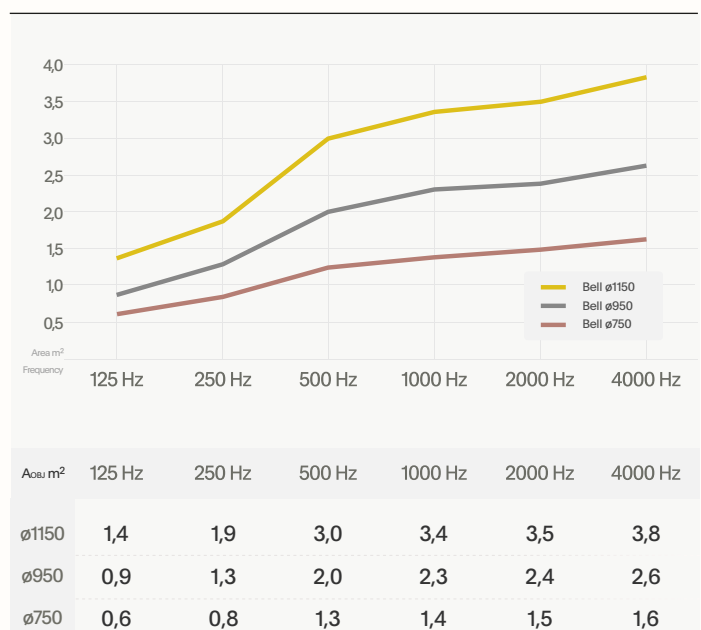

FIXING SYSTEM



The ceiling canopy (ø100×55 mm) is available in white (RAL 9016) or black (RAL 9005).

The lamp is delivered with a power cable and a mounting system (3 m) – see the Shape and Dimensions section above.

PACKAGING (LxWxH)

Depending on the size, the product is shipped in following sizes of packaging:

- 785 × 785 × 550 mm
- 985 × 985 × 690 mm
- 1185 × 1185 × 830 mm

GOLF LED LIGHT SOURCE PROPERTIES



Wattage: 19 W / 20 W
 Input Voltage: 230 VAC
 Lumen Output: 1600 lm / 1700 lm
 Efficacy: 85 lm/W
 Color Temperature: 3000K / 4000K
 CRI: >90
 UGR: 21 (22 if dark upholstery)
 Colour tolerance: MacAdam 3
 Average rated life: L90B20 50 000 h
 Degree of protection: IP20
 Dimming: Dali (Optional)
 Certificates: CE

DOWNLIGHT LIGHT SOURCE PROPERTIES



Wattage: 19 W
 Input Voltage: 230 VAC
 Lumen Output: 2400 lm
 Efficacy: 121 lm/W
 Color Temperature: 3000K / 4000K
 CRI: >80
 UGR: 22
 Colour tolerance: MacAdam 3
 Average rated life: L90B20 50 000 h
 Degree of protection: IP40
 Dimming: Dali (Optional)
 Certificates: CE

GOLF LED PHOTOMETRIC DISTRIBUTION

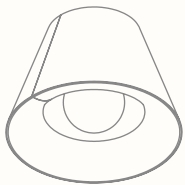

3 sizes of Golf LED diffuser depending on the lamp's size:

- ø200 mm for Bell ø750
- ø300 mm for Bell ø950
- ø400 mm for Bell ø1150

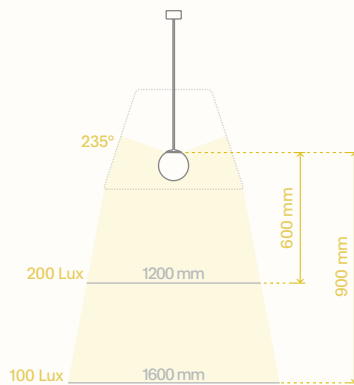

DOWNLIGHT PHOTOMETRIC DISTRIBUTION

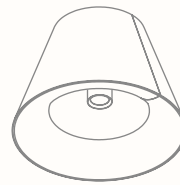

1 size of Downlight diffuser ø105 mm | H: 120 mm

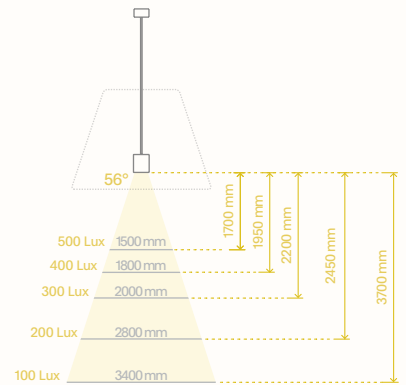

Polar intensity diagram for dark fabric Golf LED

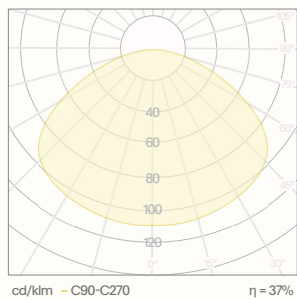

Polar intensity diagram for light fabric Golf LED

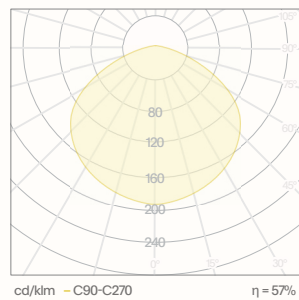

Polar intensity diagram Downlight

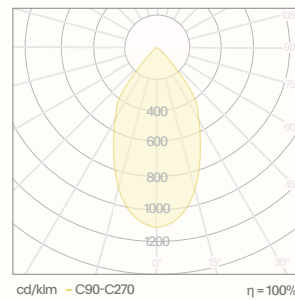

Light distribution Downlight

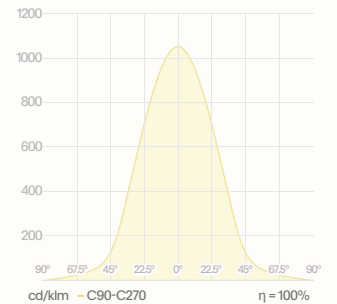

Light distribution for dark fabric Golf LED

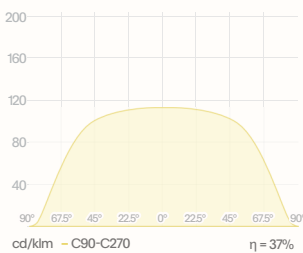

Light distribution for light fabric Golf LED

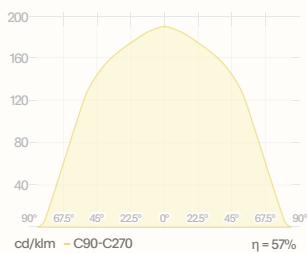

E27 FITTING PROPERTIES









The lamp is also available with an E27 screw for custom bulb arrangement (product does not contain a bulb).



Wattage: 60 W max
 Input Voltage: 230 VAC

SELECTION OF STANDARD FABRICS

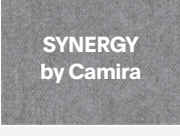
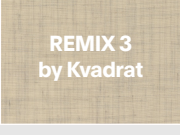
THE ENTIRE COLOR PALETTE IS AVAILABLE ON [HTTPS://MUTE.DESIGN](https://mute.design)

NAME	PG	COMPOSITION	WEIGHT g/m ²	WIDTH mm	FLAMMABILITY certificates	LIGHT FASTNESS ISO 105-B02	PILLING RES. ISO 12945-2
 ERA by Camira	1	100% polyester	320	140	BS EN 1021-1 BS EN 1021-2	5	4
 EVO		100% polyester	300	160	BS EN 1021-1 BS EN 1021-2	4-5	5
 MEDLEY by Gabriel	2	100% polyester	364	140	BS EN 1021-1 BS EN 1021-2	5-7	5-7
 MICA by Gabriel		97% post-cons. recycled polyester, 3% polyester	218	140	BS EN 1021-1 BS EN 1021-2	5-8	4-5
 SPRINT by Camira		100% polyester	325	150	BS EN 1021-1 BS EN 1021-2	6	4
 CHILI by Gabriel	3	75% post-cons. recycled polyester, 25% polyester	336	140	BS EN 1021-1 BS EN 1021-2 DIN 4102-B1	5-8	4-5
 SYNERGY by Camira		95% new wool, 5% polyamide	400	140	BS EN 1021-1 BS EN 1021-2	5	4
 REMIX 3 by Kvadrat	4	90% new wool, 10% nylon	300	140	BS EN 1021-1 BS EN 1021-2	6	3-4
 SELECT by Gabriel		85% New Zealand wool, 15% polyamide	364	140	BS EN 1021-1 BS EN 1021-2	5-8	4-5
 STEELCUT TRIO 3 by Kvadrat	5	90% new wool, 10% nylon	550	140	BS EN 1021-1 BS EN 1021-2	6-7	4

ZIP COLORS

The sound absorbing surface is decorated with a vertical zipper that covers a seam of chosen fabric. The zipper is available in four basic colors:



CARE

- Keep the product dry and away from air conditioning and ventilation systems
- Keep away from direct sun light and heat sources
- Vacuum regularly